

# Outdoor signage of NLB office buildings and branches

3D outdoor signage light elements



# Outdoor signage of NLB office buildings and branches

- 01** Introduction of outdoor light signange elements
- 02** Schematic plans of 3D light elements



# Introduction of outdoor light signage elements

NLB business buildings and branches vary in size and architecture. The following manual presents schematic plans of 3D light elements and their usage on NLB office buildings and branches to withhold consistency in visual communication.

The signage consists of elements used to enhance brand awareness and recognition and enhance user experience with better visibility, recognition, consistency and hierarchy of applied information.

[www.nlb.si/brand/business-buildings/outdoor-signage](http://www.nlb.si/brand/business-buildings/outdoor-signage)

# Office building

[www.nlb.si/brand/business-buildings/outdoor-signage](http://www.nlb.si/brand/business-buildings/outdoor-signage)

1



1

## Introduction of outdoor signage 3D light elements

- 1 Symbol
- 2 Signage columns



# Branch office

[www.nlb.si/brand/business-buildings/outdoor-signage](http://www.nlb.si/brand/business-buildings/outdoor-signage)

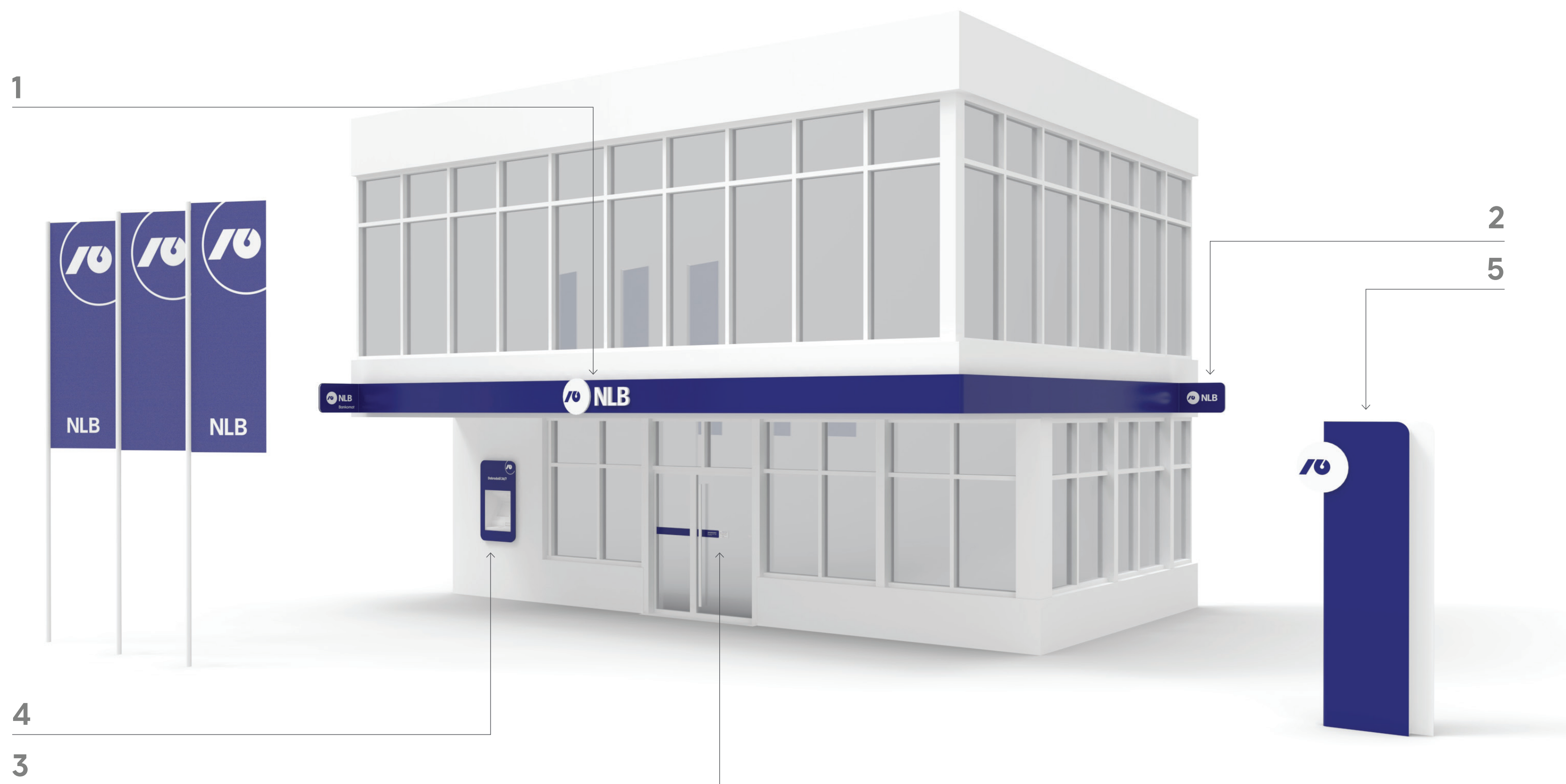

## Introduction of outdoor signage 3D light elements

- 1 Symbol
- 2 Signboard
- 3 Entrance door  
Information board
- 4 Equipment of ATMs
- 5 Signage columns

# Materials and colors

<https://www.nlb.si/brand/business-buildings/outdoor-signage/materials-colors>

# Materials and colors

3D light elements	Kode	Aluminium (3 mm)	Acrylic	Foil for light elements	LED	Other material	Notes
1. Symbol NLB 50 cm	NLB_SY_50		· Crylux, milky/3014, Polycasa	· Hexis T.5274 cut foil + IMAGin JT WT-PT 9700 white base foil (two-layer gluing)	· 6000K, 56W, BaltLED		· Painted border of the letters RAL 9003
2. Light banner with the NLB symbol	NLB_SY_LB_S	· RAL Design 290 20 35 · RAL 9003	· Crylux, milky/3014, Polycasa	· Hexis T.5274 cut foil + IMAGin JT WT-PT 9700 white base foil (two-layer gluing)	· 6000K, 16W/tM, BaltLED		· Painted border of the letters RAL 9003
3. Light banner - basic element	NLB_SY_LB	· RAL Design 290 20 35 · RAL 9003	· Crylux, milky/3014, Polycasa		· 6000K, 16W/tM, BaltLED		
4. Light banner - corner element for ending of light banner, left	NLB_SY_LB_CL	· RAL Design 290 20 35 · RAL 9003	· Crylux, milky/3014, Polycasa		· 6000K, 16W/tM, BaltLED		
5. Light banner - corner element for ending of light banner, right	NLB_SY_LB_CD	· RAL Design 290 20 35 · RAL 9003	· Crylux, milky/3014, Polycasa		· 6000K, 16W/tM, BaltLED		
6. Light banner - corner element for signboard, left	NLB_SY_LB_CL_SB	· RAL Design 290 20 35 · RAL 9003	· Crylux, milky/3014, Polycasa		· 6000K, 16W/tM, BaltLED		
7. Light banner - corner element for signboard, right	NLB_SY_LB_CR_SB	· RAL Design 290 20 35 · RAL 9003	· Crylux, milky/3014, Polycasa		· 6000K, 16W/tM, BaltLED		
8. Symbol NLB 80 cm, grey inscription	NLB_SY_80_G		· Night&Day 126280022 (Grey&White), Altuglas · Crylux, milky/3014, Polycasa	· Hexis T.5274 cut foil + IMAGin JT WT-PT 9700 white base foil (two-layer gluing)	· Sign: 6000K, 160W, BaltLED · Letters: 6000K, 83W, BaltLED		· Painted border of the letters RAL 7012
9. Symbol NLB 80 cm, white inscription	NLB_SY_80_W		· Crylux, milky/3014, Polycasa	· Hexis T.5274 cut foil + IMAGin JT WT-PT 9700 white base foil (two-layer gluing)	· Sign: 6000K, 160W, BaltLED · Letters: 6000K, 83W, BaltLED		· Painted border of the letters RAL 9003
10. Symbol NLB 140 cm, grey inscription	NLB_SY_140_G	· RAL Design 290 20 35 · RAL 7037	· Night&Day 126280022 (Grey&White), Altuglas · Crylux, milky/3014, Polycasa	· Hexis T.5274 cut foil + IMAGin JT WT-PT 9700 white base foil (two-layer gluing)	· Sign: 6000K, 54W, BaltLED · Letters: 6000K, 86W, BaltLED		
11. Symbol NLB 140 cm, white inscription	NLB_SY_140_W	· RAL Design 290 20 35 · RAL 9003	· Crylux, milky/3014, Polycasa	· Hexis T.5274 cut foil + IMAGin JT WT-PT 9700 white base foil (two-layer gluing)	· Sign: 6000K, 54W, BaltLED · Letters: 6000K, 86W, BaltLED		
12. Sign 140 cm	NLB_SY_S_140	· RAL Design 290 20 35	· Crylux, milky/3014, Polycasa	· Hexis T.5274 cut foil + IMAGin JT WT-PT 9700 white base foil (two-layer gluing)	· 6000K, 54W, BaltLED		
13. Signboard NLB	NLB_SB	· RAL Design 290 20 35 · RAL 9003	· Crylux, milky/3014, Polycasa	· Hexis T.5274 cut foil + IMAGin JT WT-PT 9700 white base foil (two-layer gluing)	· 6000K, 35W, BaltLED		
14. Signboard NLB ATM	NLB_SB_ATM	· RAL Design 290 20 35 · RAL 9003	· Crylux, milky/3014, Polycasa	· Hexis T.5274 cut foil + IMAGin JT WT-PT 9700 white base foil (two-layer gluing)	· 6000K, 46W, BaltLED		
15. Info board 45 x 68 cm	NLB_IB_45	· RAL Design 290 20 35 · RAL 9003	· Crylux, milky/3014, Polycasa	· Hexis T.5274 cut foil + IMAGin JT WT-PT 9700 white base foil (two-layer gluing)	· 6000K, 35W, BaltLED		
16. Info board 55 x 68 cm	NLB_IB_55	· RAL Design 290 20 35 · RAL 9003	· Crylux, milky/3014, Polycasa	· Hexis T.5274 cut foil + IMAGin JT WT-PT 9700 white base foil (two-layer gluing)	· 6000K, 35W, BaltLED		
17. Casing in the width of an ATM	NLB_ATM_CW			· IMAGin JT WT-PT 9700, Opal white		Transparent Polycarbonat, print Pantone 2745 C	
18. The Canopy for ATM	NLB_ATM_C	· RAL Design 290 20 35 · RAL 9003	· Crylux, milky/3014, Polycasa	· Hexis T.5274 cut foil + IMAGin JT WT-PT 9700 white base foil (two-layer gluing) · IMAGin JT WT-PT 9700, Opal white	· Sign: 6000K, 80W, BaltLED · Canopy: 6000K, 43W, BaltLED		
19. Freestanding ATM with light element	NLB_ATM_FS	· RAL Design 290 20 35 · RAL 9003	· Crylux, milky/3014, Polycasa	· Hexis T.5274 cut foil + IMAGin JT WT-PT 9700 white base foil (two-layer gluing)	· Sign: 6000K, 80W, BaltLED · Enclosure: 6000K, 46W, BaltLED		
20. Signage column 300 cm	NLB_SC_300	· RAL Design 290 20 35 · RAL 9003	· Crylux, milky/3014, Polycasa	· Hexis T.5274 cut foil + IMAGin JT WT-PT 9700 white base foil (two-layer gluing) · IMAGin JT WT-PT 9700, Opal white	· Sign: 6000K, 44W, BaltLED · Letters NLB Banka and border: 6000K, 56W, BaltLED		
21. Signage column 500 cm	NLB_SC_500	· RAL Design 290 20 35 · RAL 9003	· Crylux, milky/3014, Polycasa	· Hexis T.5274 cut foil + IMAGin JT WT-PT 9700 white base foil (two-layer gluing) · IMAGin JT WT-PT 9700, Opal white	· Sign: 6000K, 44W, BaltLED · Letters NLB Banka and border: 6000K, 56W, BaltLED		
22. Signage column with bench 300 cm	NLB_SC_300_B	· RAL Design 290 20 35 · RAL 9003	· Crylux, milky/3014, Polycasa	· Hexis T.5274 cut foil + IMAGin JT WT-PT 9700 white base foil (two-layer gluing) · IMAGin JT WT-PT 9700, Opal white	· Sign: 6000K, 44W, BaltLED · Letters NLB Banka and border: 6000K, 56W, BaltLED		



## Materials and colors

Painted sheet of aluminum with acrylic



Acrylic, light part  
Crylux, milky/3014, Polycasa

Acrylic, light part  
Crylux, milky/3014, Polycasa

Painted edge  
RAL Design 290 20 35

Painted sheet of aluminium  
RAL 9003

Acrylic, light part  
Crylux, milky/3014, Polycasa

Painted sheet of aluminium  
RAL Design 290 20 35

Acrylic, light part  
Crylux, milky/3014, Polycasa

Two layers of foil  
Hexis T.5274 cut foil+ IMAGin JT WT-PT 9700  
white base foil (two -layer gluing)



Painted edge  
RAL Design 290 20 35

Painted sheet of aluminium  
RAL 9003

Acrylic, light part  
Crylux, milky/3014, Polycasa

Painted sheet of aluminium  
RAL Design 290 20 35

The light elements, which are made of painted **aluminum sheet** and **acrylic**, are made in the way shown in the left visualizations.

The shown manufacturing method is used for the following light elements:

- Light banner with symbol NLB
- Signboard NLB
- Signboard NLB ATM
- Info board 45 x 68 cm
- Info board 55 x 68 cm
- Canopy for ATM
- Free standing ATM with light element
- Signage column



# Materials and colors

Symbol 50 cm, acrylic

Use of symbol on light banner and historic buildings

Acrylic, light part  
Crylux, milky/3014, Polycasa

Two layers of foil  
Hexis T.5274 cut foul + IMAGin JT WT-PT 9700  
white base foil (two-layer gluing)

Acrylic, painted border  
RAL 9003, block color

Acrylic, light part  
Crylux, milky/3014, Polycasa

Acrylic, painted border  
RAL 9003, block color



# Materials and colors

## Symbol 80 cm, acrylic version

### Usage of symbol on light surface

Acrylic, light part

Crylux, milky/3014, Polycasa

Acrylic, light part + two layers of foil

- Crylux, milky/3014, Polycasa
- Hexis T.5274 cut foil + IMAGin JT WT-PT 9700 white base foil (two-layer gluing)



Acrylic, light part  
Night&Day 126280022 (Grey&White), Altuglas

Acrylic, painted border  
RAL 7012, block color

### Usage of symbol on dark surface

Acrylic, light part

Crylux, milky/3014, Polycasa

Acrylic, light part + two layers of foil

- Crylux, milky/3014, Polycasa
- Hexis T.5274 cut foil + IMAGin JT WT-PT 9700 white base foil (two-layer gluing)

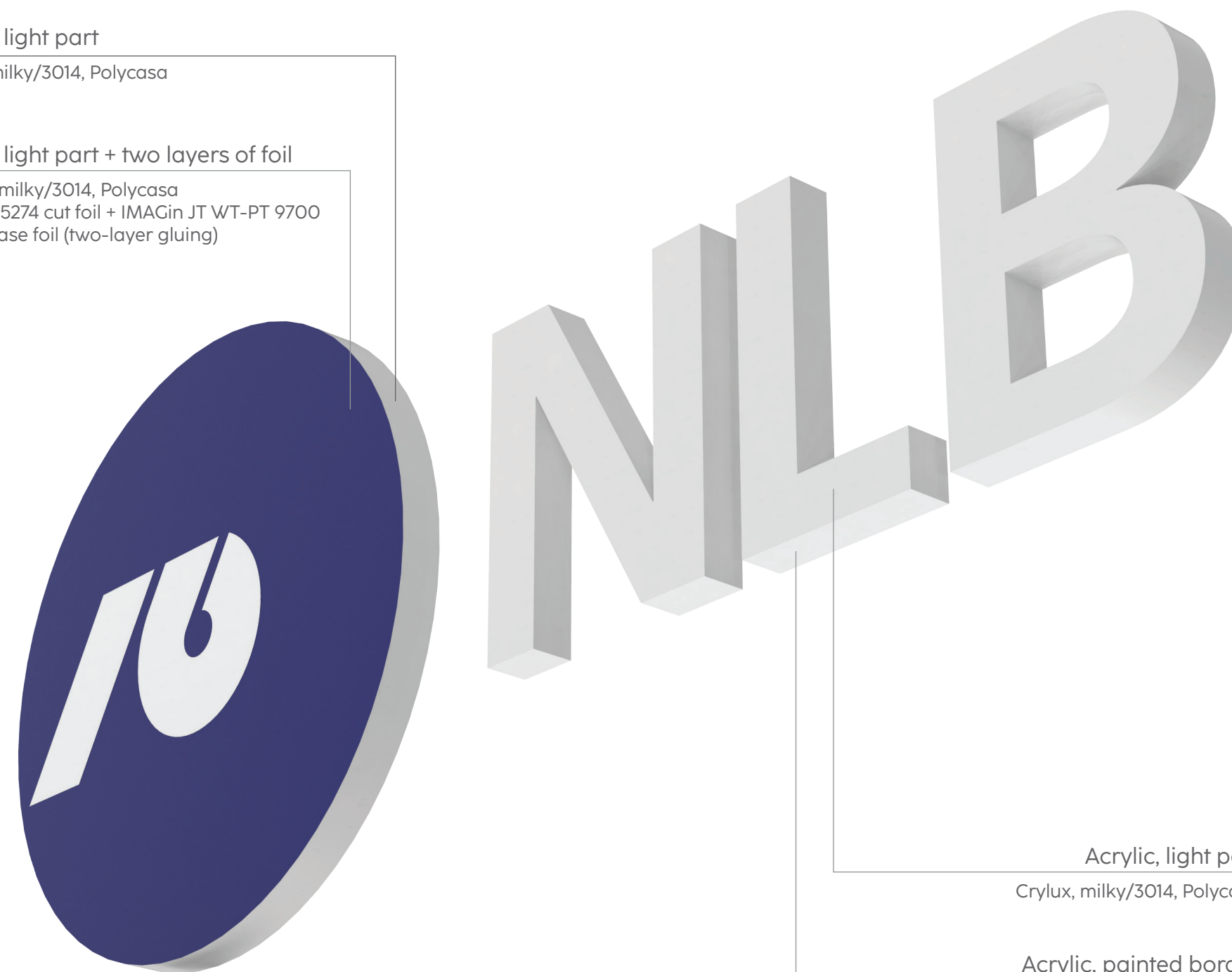

Acrylic, light part  
Crylux, milky/3014, Polycasa

Acrylic, painted border  
RAL 9003, block color

# Materials and colors

Symbol 140 cm, cassette version

## Usage of symbol on light surface

Acrylic, light part + two layers of foil

- Crylux, milky/3014, Polycasa
- Hexis T.5274 cut foil + IMAGin JT WT-PT 9700 white base foil (two-layer gluing)

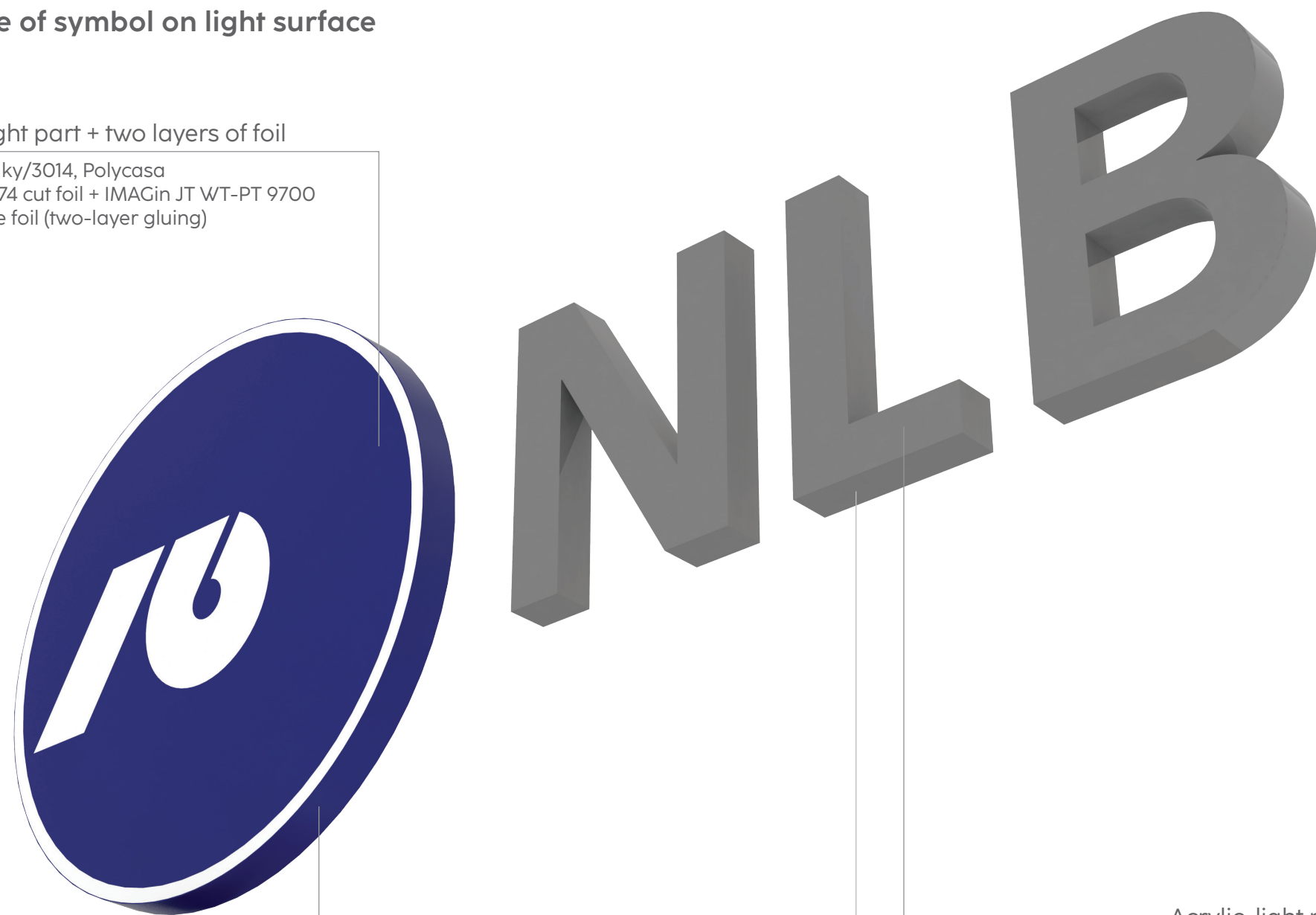

Painted sheet of aluminum/edge  
RAL Design 290 20 35

Acrylic, light part  
Night&Day 126280022 (Grey&White), Altuglas

Painted sheet of aluminum/edge  
RAL 7037

## Usage of symbol on dark surface

Acrylic, light part + two layers of foil

- Crylux, milky/3014, Polycasa
- Hexis T.5274 cut foil + IMAGin JT WT-PT 9700 white base foil (two-layer gluing)



Painted sheet of aluminum/edge  
RAL Design 290 20 35

Acrylic, light part  
Crylux, milky/3014, Polycasa

Painted sheet of aluminum/edge  
RAL 9003

# Schematic plans of 3D light elements

## Symbol

- Light banner with the NLB symbol
- Symbol 80 cm
- Symbol 140 cm
- Sign 140 cm

## Signboard

- NLB Signboard
- NLB ATM Signboard

## Entrance door – information board

- Information board 45 x 68 cm
- Information board 55 x 68 cm

## Equipment of ATMs

- Casing in the width of an ATM
- The Canopy
- Freestanding ATM with light element

## Signage columns

- Signage column 300 cm
- Signage column 500 cm
- Signage column with bench 300 cm





# Symbol

NLB

- 1 Symbol 50 cm
- 2 Light banner with the NLB symbol
- 3 Symbol 80 cm
- 4 Symbol 140 cm
- 5 Sign 140 cm



# Symbol

## Symbol 50 cm

<https://www.nlb.si/brand/business-buildings/outdoor-signage/symbol>

3D light elements	CODE
1. Symbol NLB 50 cm	NLB_SY_50

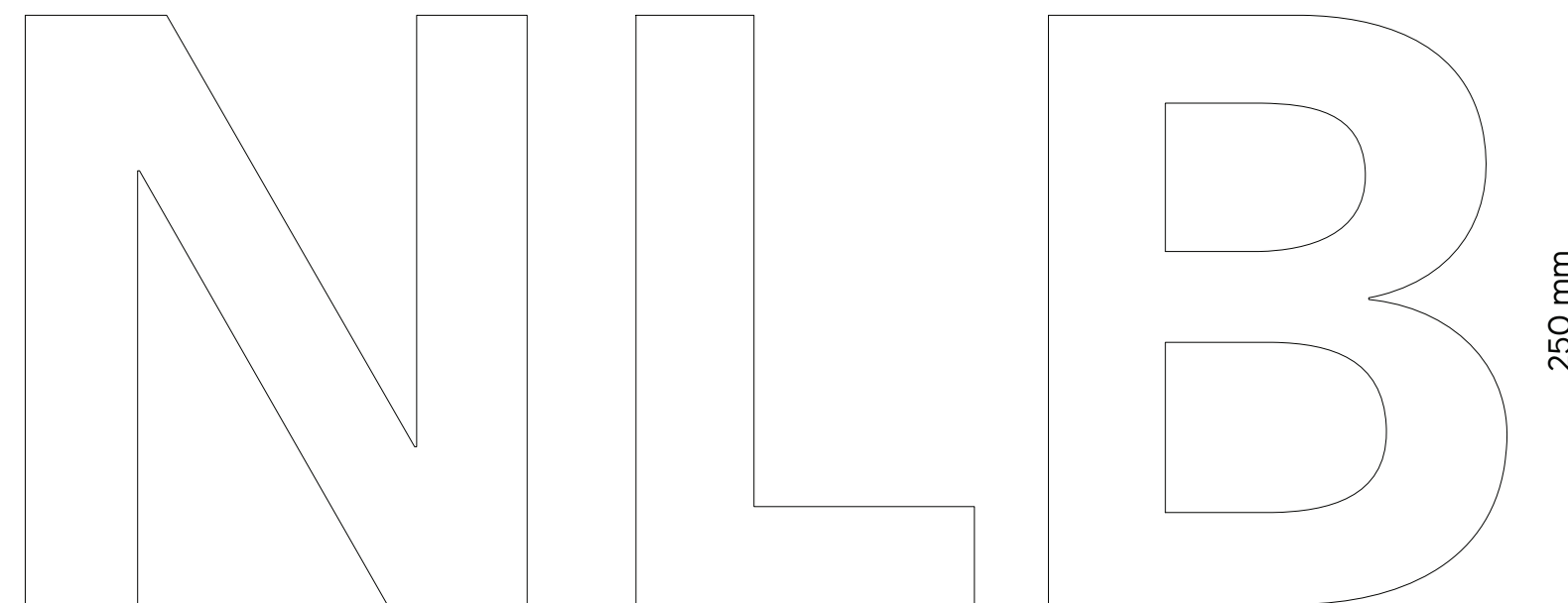
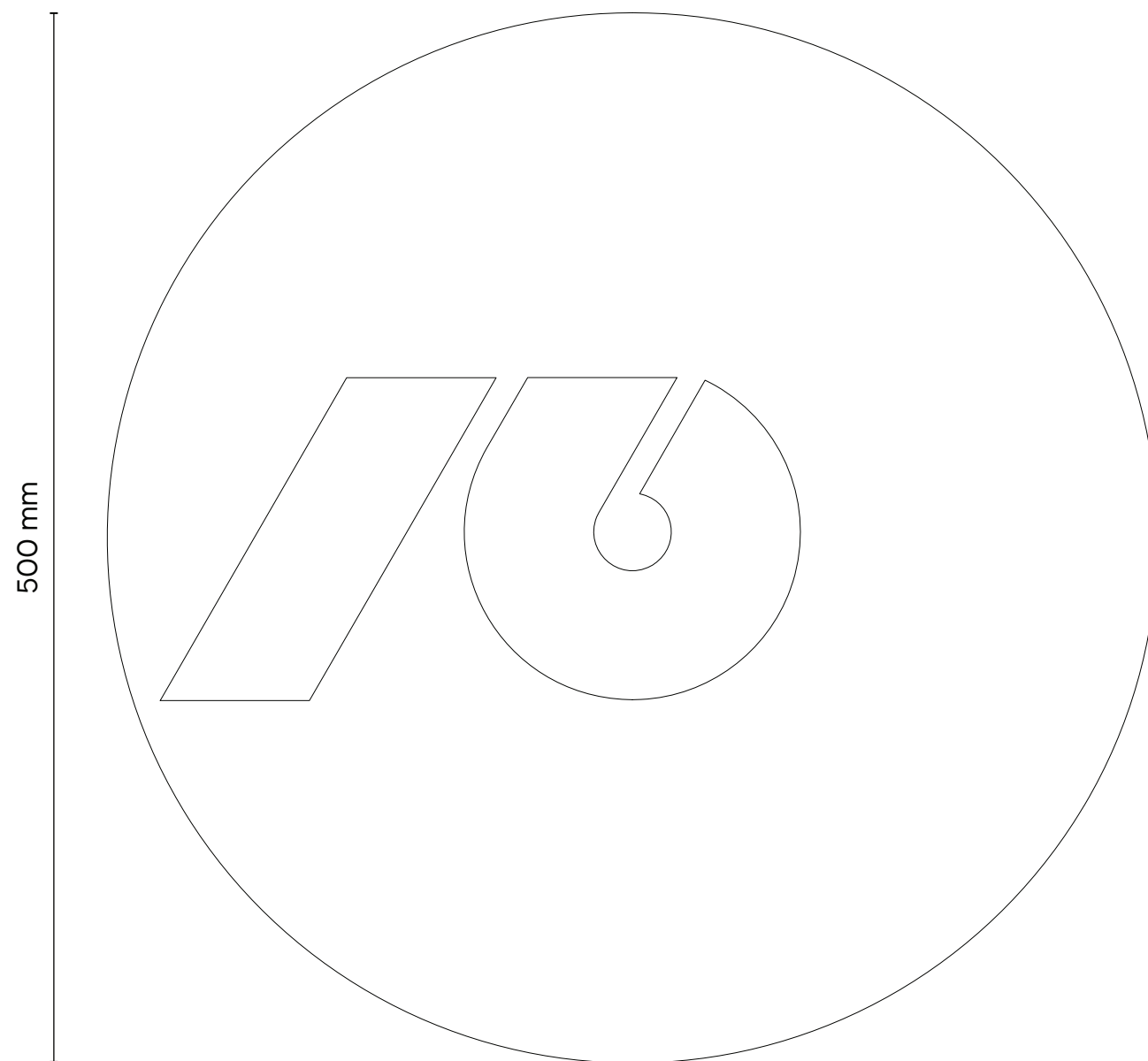
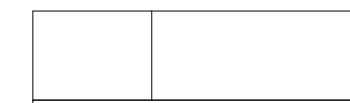
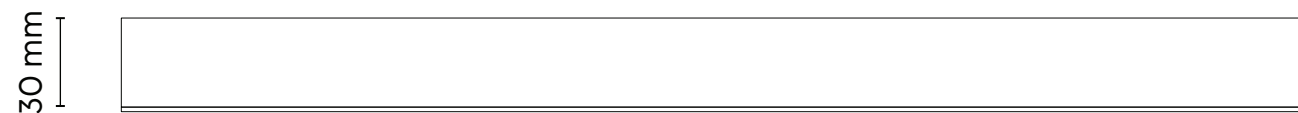

# Symbol

## Light banner with the NLB symbol

[www.nlb.si/brand/business-buildings/outdoor-signage/symbol](http://www.nlb.si/brand/business-buildings/outdoor-signage/symbol)

3D light elements	CODE
2. Light banner with the NLB symbol	NLB_SY_LB_S
3. Light banner - basic element	NLB_SY_LB
4. Light banner - corner element for ending of light banner, left	NLB_SY_LB_CL
5. Light banner - corner element for ending of light banner, right	NLB_SY_LB_CR
6. Light banner - corner element for signboard, left	NLB_SY_LB_CL_SB
7. Light banner - corner element for signboard, right	NLB_SY_LB_CR_SB

2. Light banner with NLB symbol

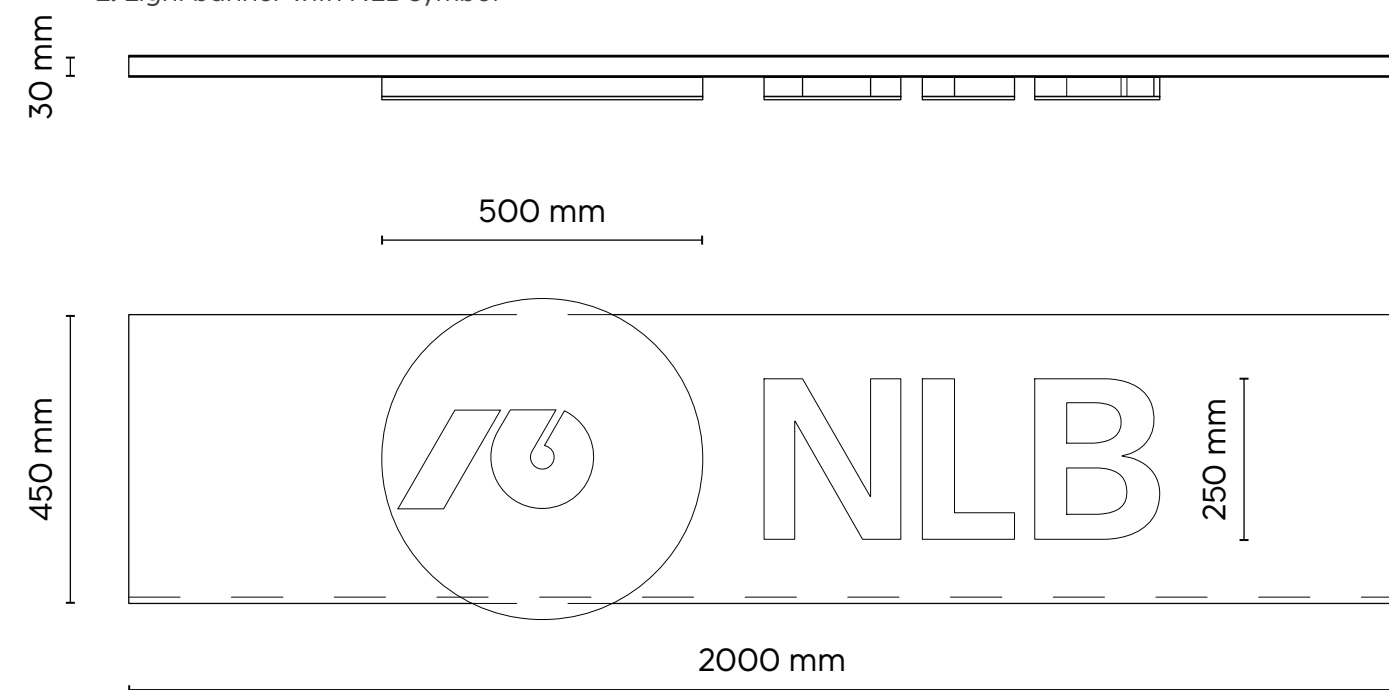

3. Light banner - corner element for ending, left

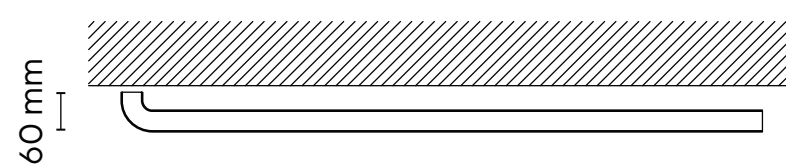

3. Light banner - basic element

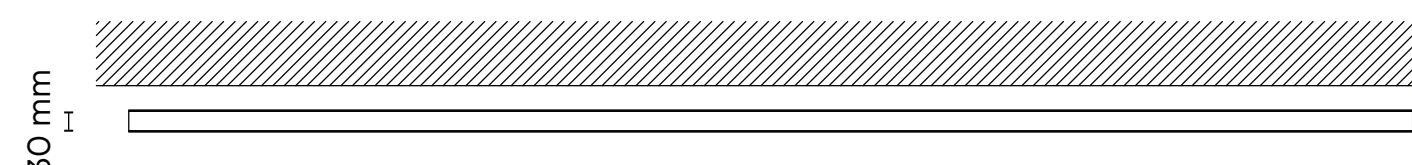

\* The minimum prescribed length of the light banner only in the case with the NLB symbol.

5. Light banner - corner element for ending, right

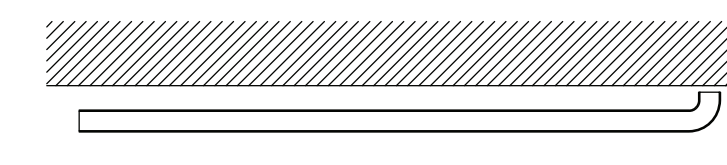

6. Light banner - corner element for signboard, left

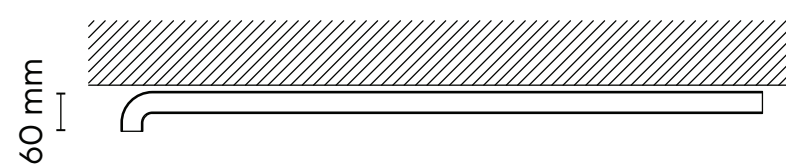

7. Light banner - corner element for signboard, right

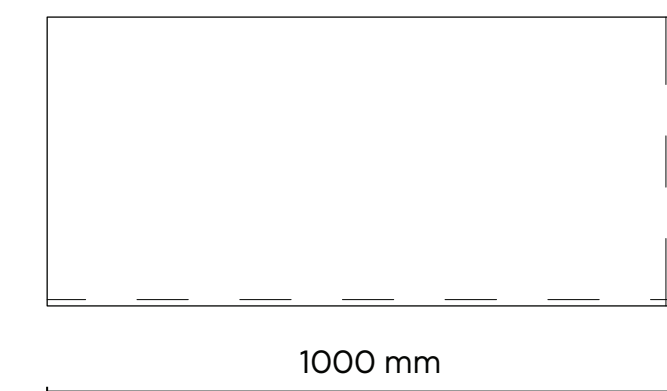
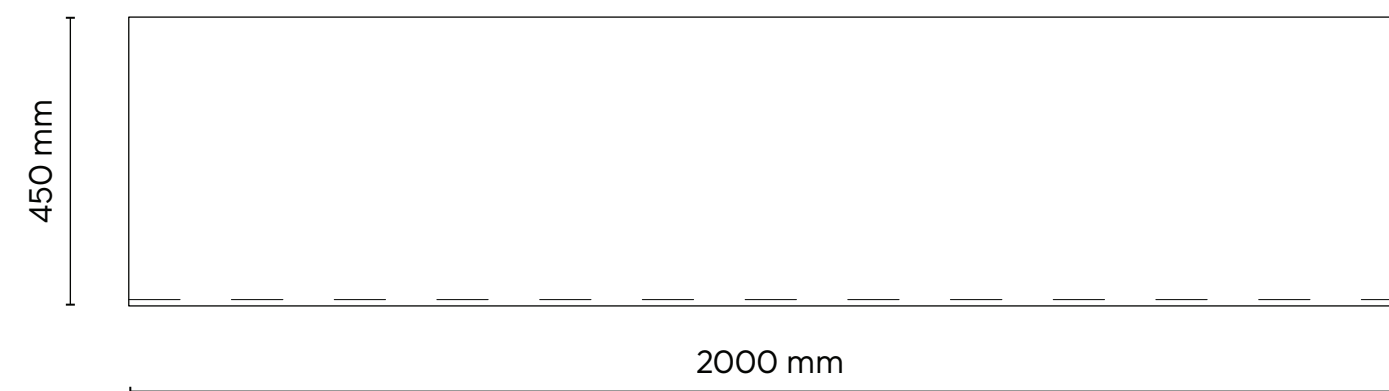
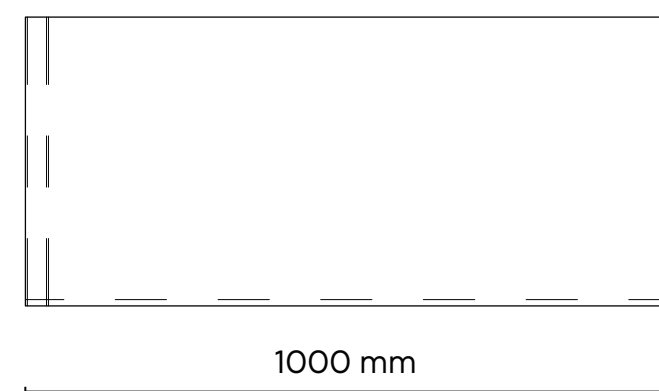
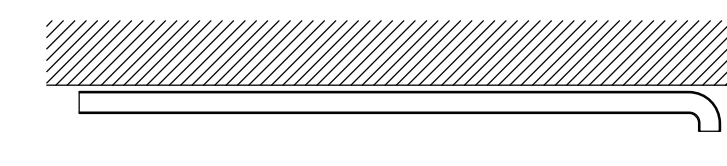

# Symbol

## Symbol 80 cm

[www.nlb.si/brand/business-buildings/outdoor-signage/symbol](http://www.nlb.si/brand/business-buildings/outdoor-signage/symbol)

3D light elements	CODE
8. NLB Symbol 80 cm, grey inscription	NLB_SY_80_G
9. NLB Symbol 80 cm, white inscription	NLB_SY_80_W

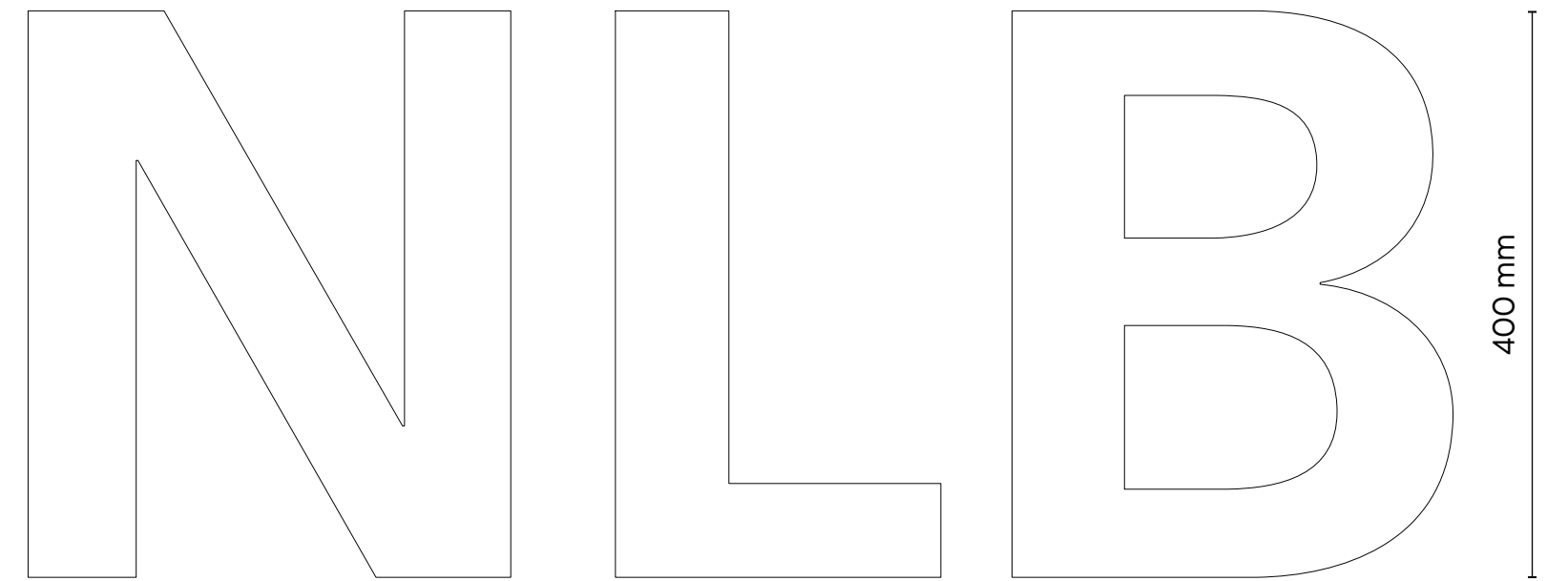
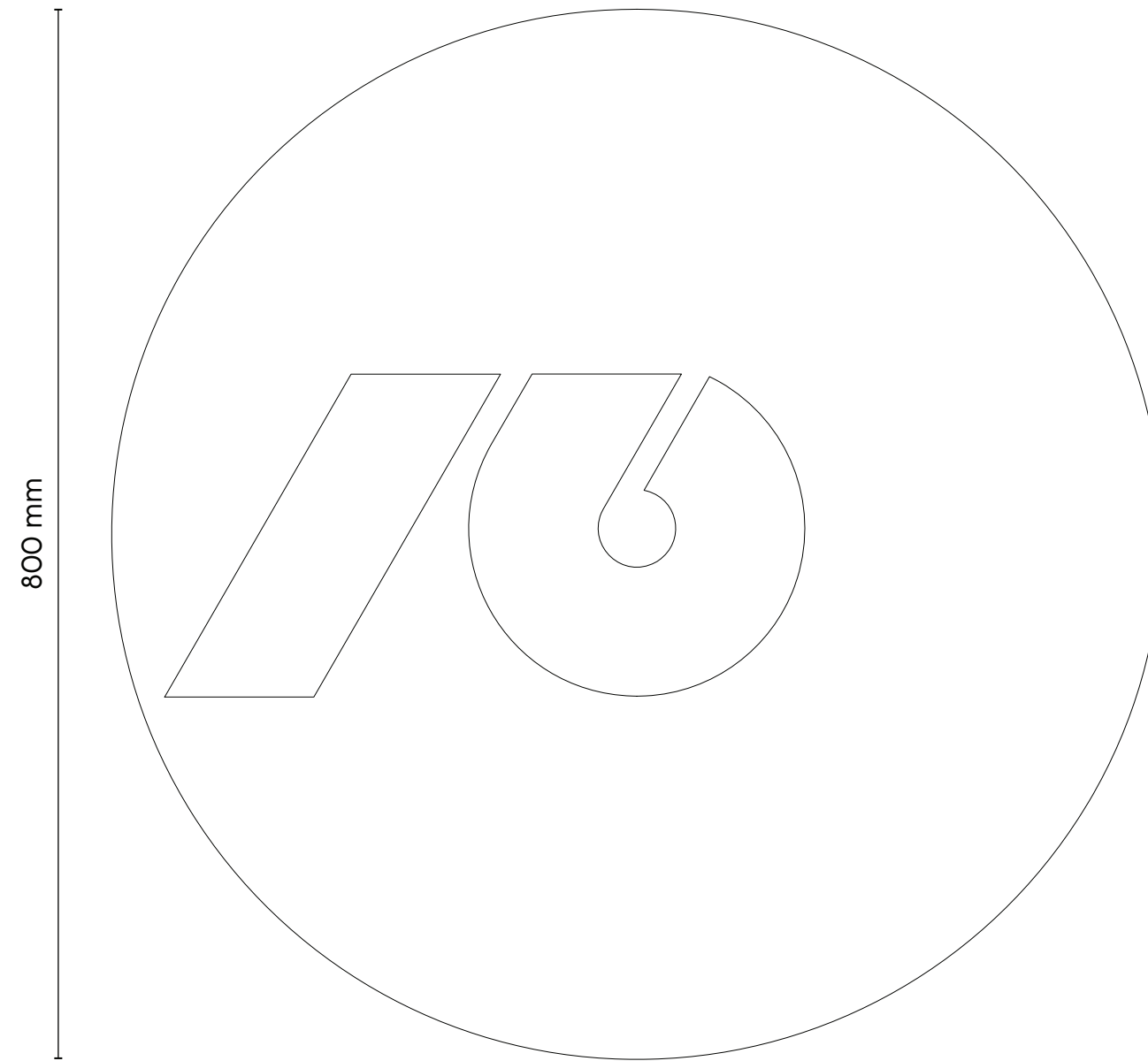
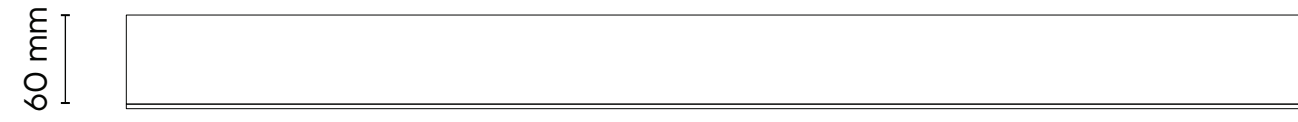



# Symbol

## Symbol 140 cm

[www.nlb.si/brand/business-buildings/outdoor-signage/symbol](http://www.nlb.si/brand/business-buildings/outdoor-signage/symbol)

3D light elements	CODE
10. NLB Symbol 140 cm, grey inscription	NLB_SY_140_G
11. NLB Symbol 140 cm, white inscription	NLB_SY_140_W

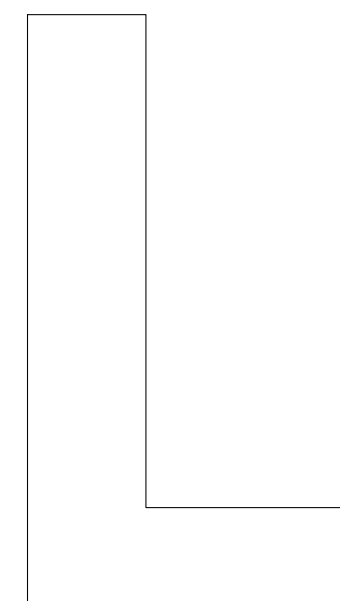
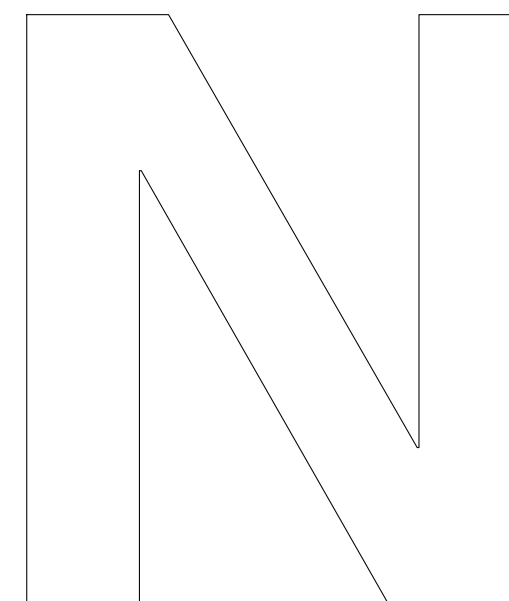
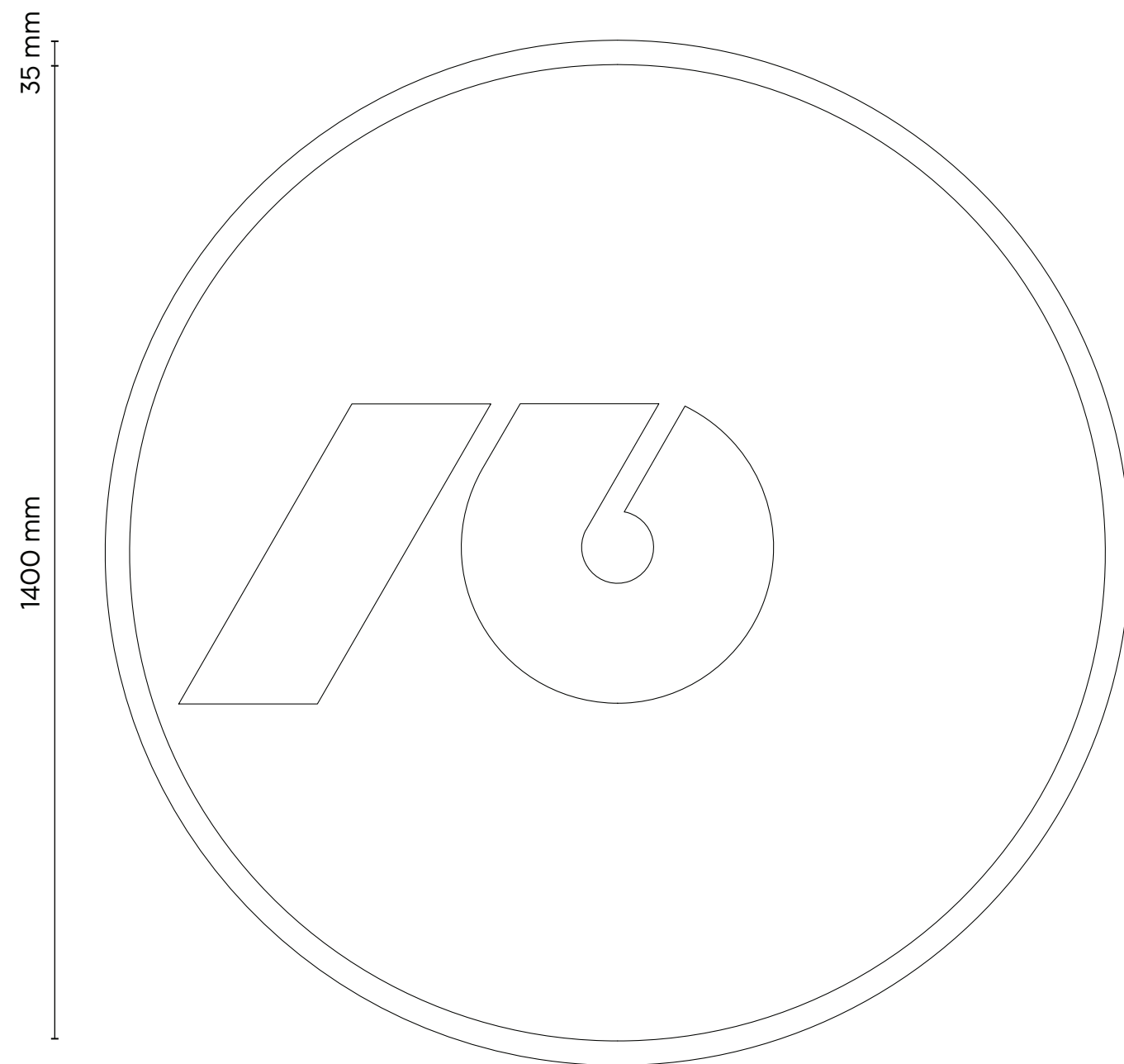
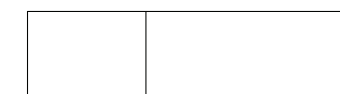
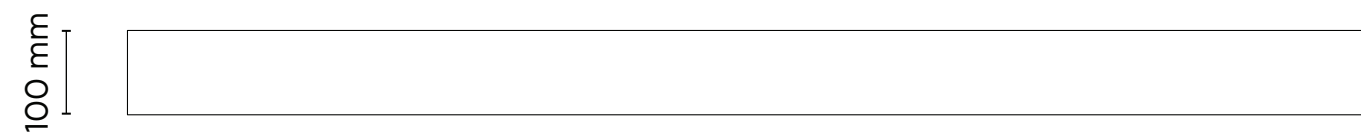

700 mm

# Symbol

## Sign 140 cm

[www.nlb.si/brand/business-buildings/outdoor-signage/symbol](http://www.nlb.si/brand/business-buildings/outdoor-signage/symbol)

3D light elements	CODE
12. NLB Sign 140 cm	NLB_SY_S_140

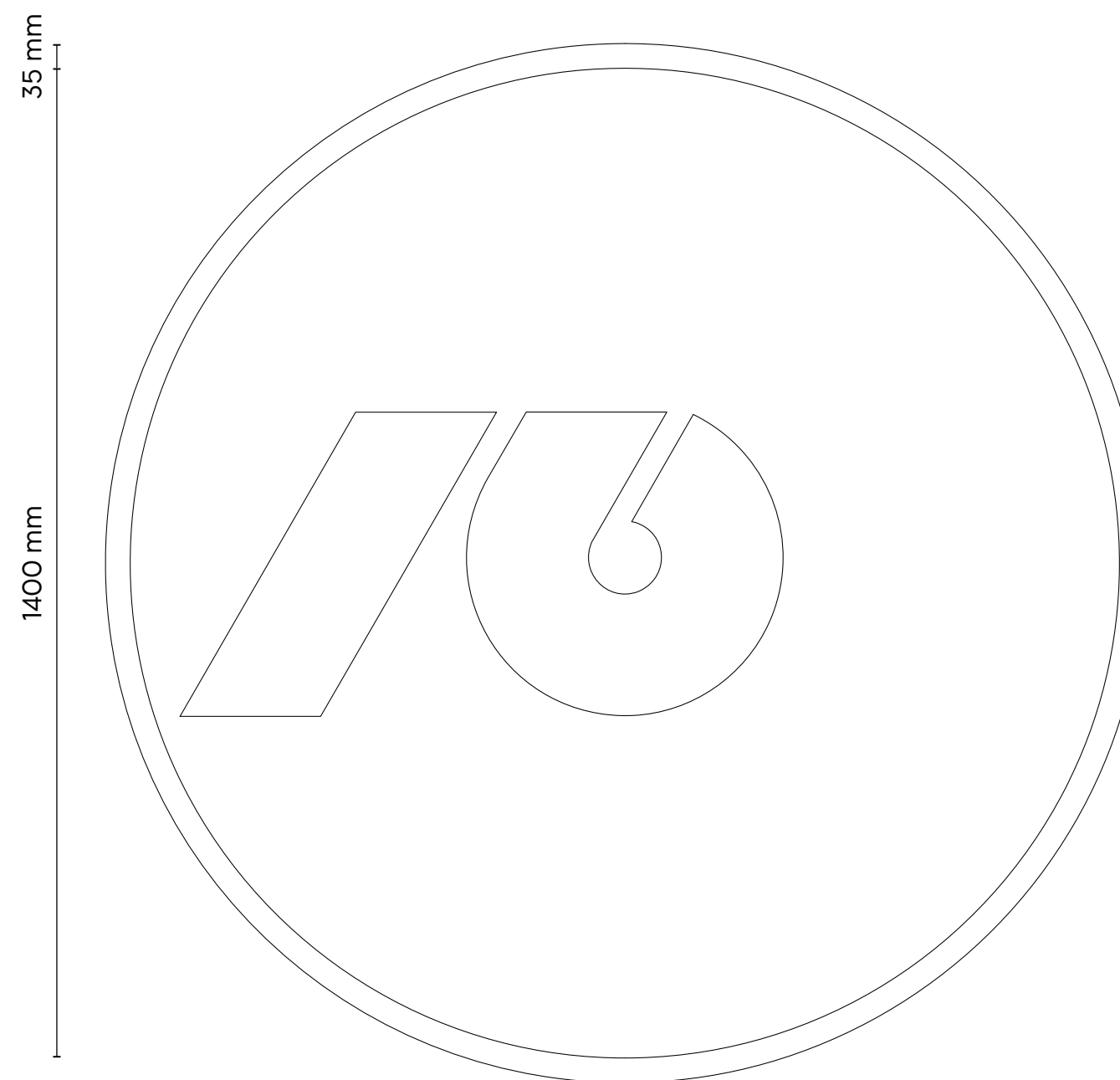
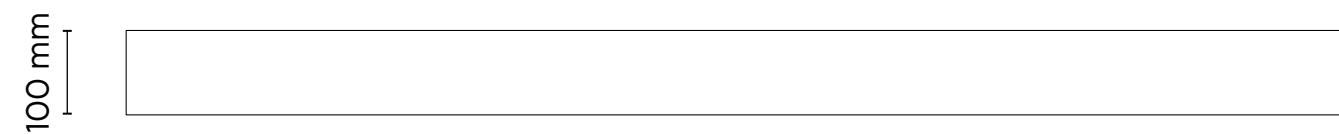

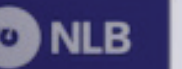

# Signboard

- 1 NLB Signboard
- 2 NLB ATM Signboard

# Signboard

## NLB Signboard

[www.nlb.si/brand/business-buildings/outdoor-signage/nlb-and-atm-signboard](http://www.nlb.si/brand/business-buildings/outdoor-signage/nlb-and-atm-signboard)

3D light elements	CODE
13. NLB Signboard	NLB_SB

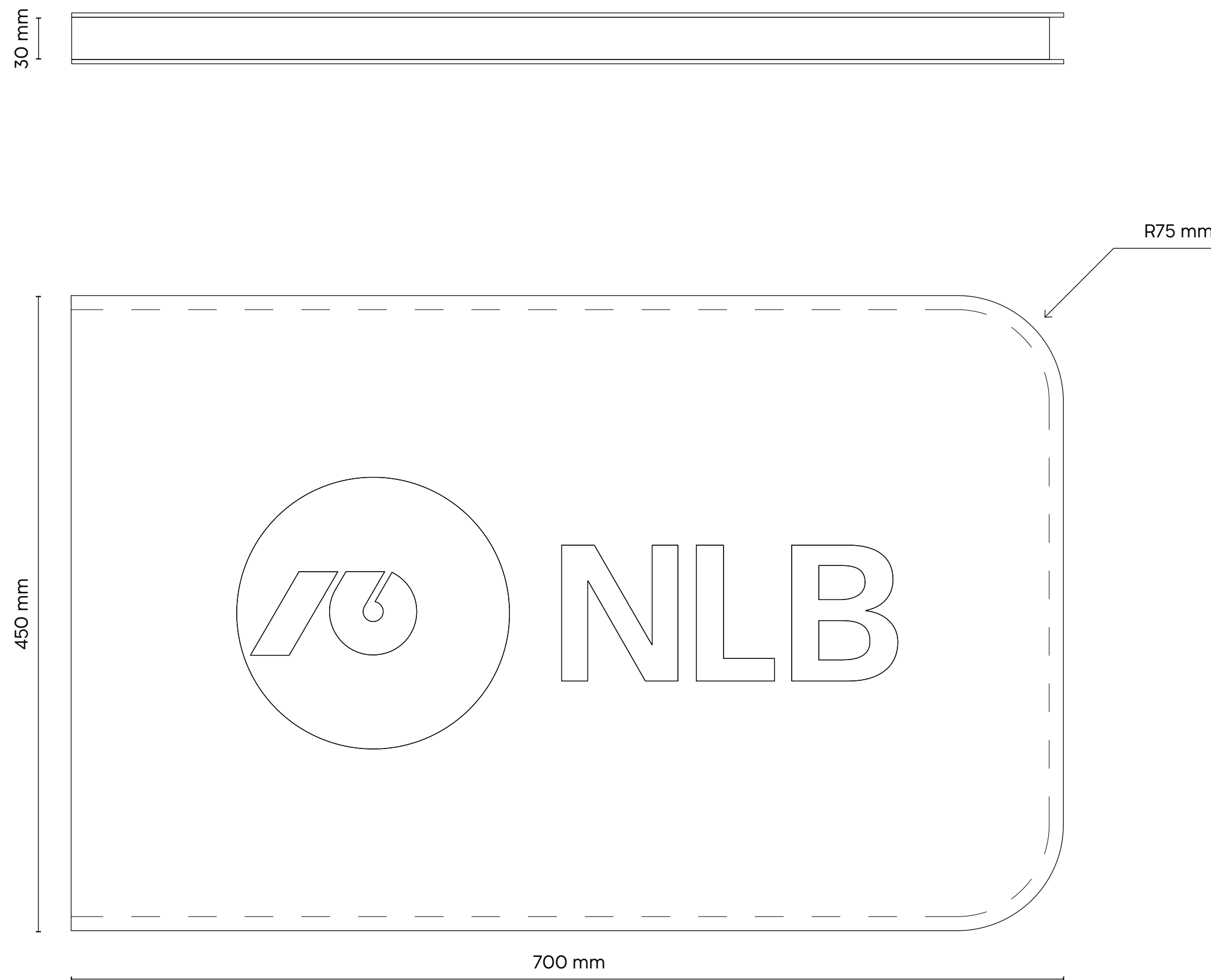



# Signboard

## NLB ATM Signboard

[www.nlb.si/brand/business-buildings/outdoor-signage/nlb-and-atm-signboard](http://www.nlb.si/brand/business-buildings/outdoor-signage/nlb-and-atm-signboard)

3D light elements	CODE
14. NLB ATM Signboard	NLB_SB_ATM

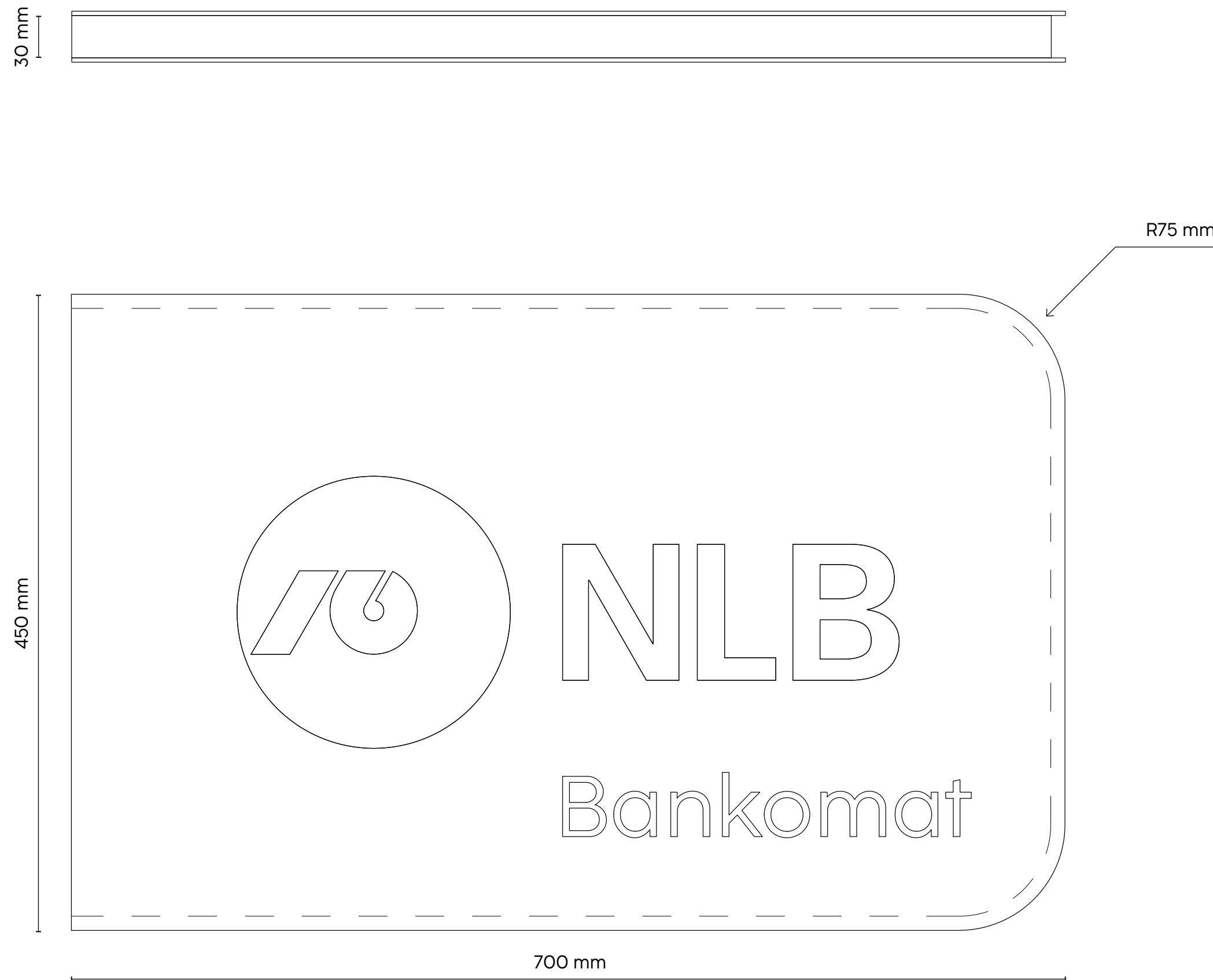

# Entrance door

- 1 Information board 45 x 68 cm
- 2 Information board 55 x 68 cm



# Entrance door

## Information board 45 x 68 cm

[www.nlb.si/brand/business-buildings/outdoor-signage/entrance-door](http://www.nlb.si/brand/business-buildings/outdoor-signage/entrance-door)

3D light elements	CODE
15. Information board 45 x 68 cm	NLB_IB_45

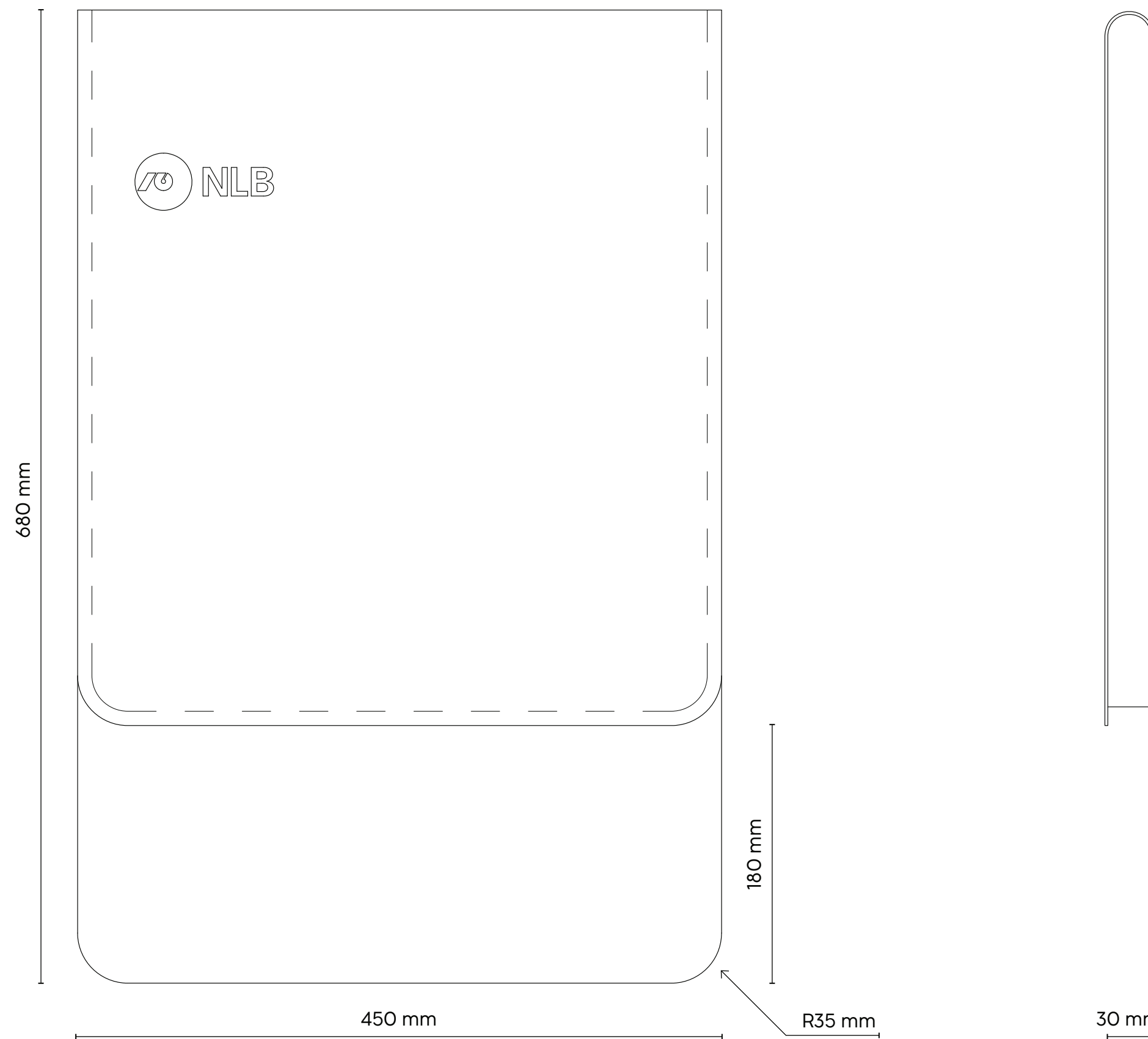

# Entrance door

## Information board 55 x 68 cm

[www.nlb.si/brand/business-buildings/outdoor-signage/entrance-door](http://www.nlb.si/brand/business-buildings/outdoor-signage/entrance-door)

3D light elements	CODE
16. Information board 55 x 68 cm	NLB_IB_55

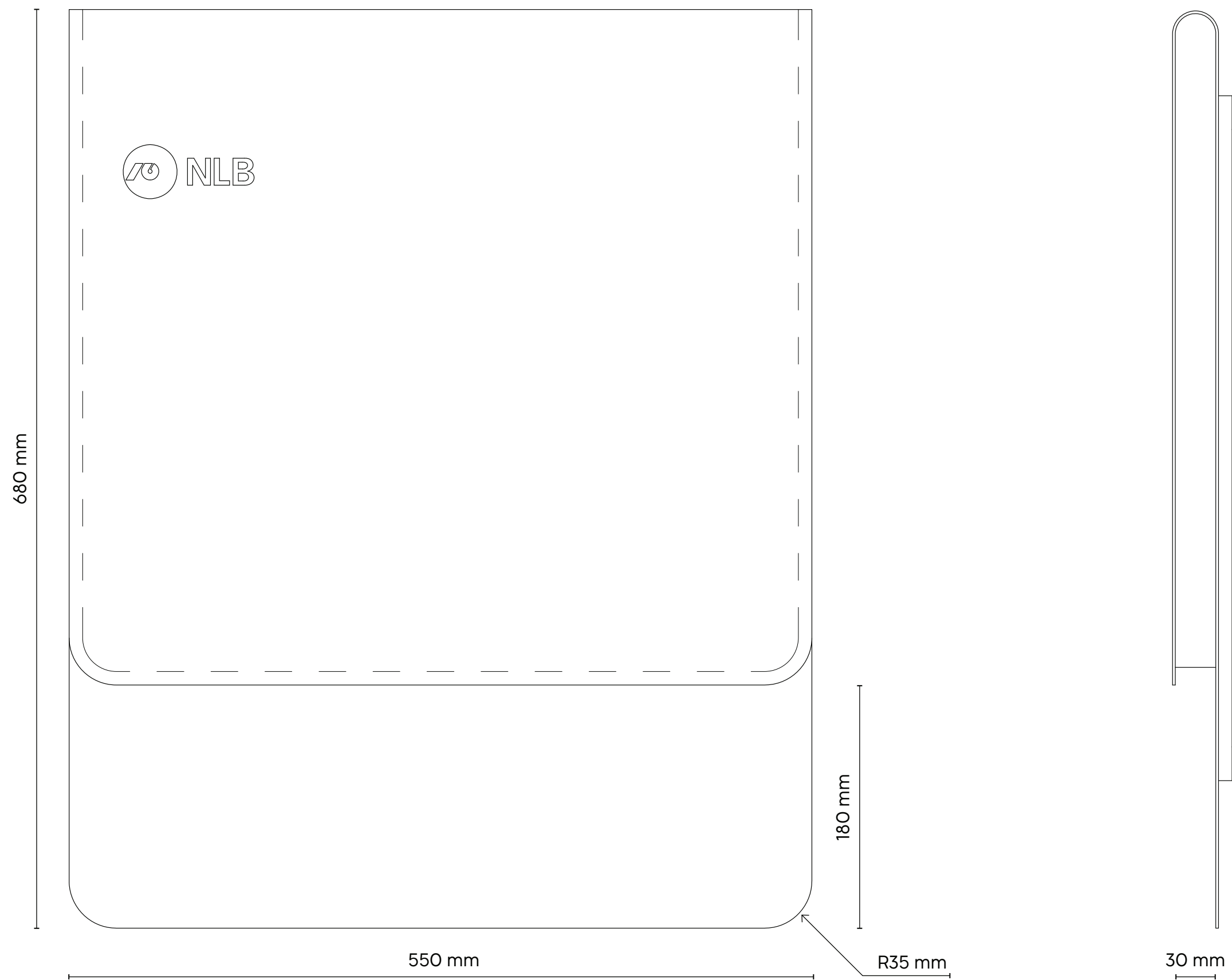



# Equipment of ATMs

- 1 Casing in the width of an ATM
- 2 The Canopy
- 3 Freestanding ATM with light element



# Equipment of ATMs

## Casing in the width of an ATM

[www.nlb.si/brand/business-buildings/outdoor-signage/equipment-of-atms](http://www.nlb.si/brand/business-buildings/outdoor-signage/equipment-of-atms)

3D light elements	CODE
17. Casing in the width of an ATM	NLB_ATM_CW

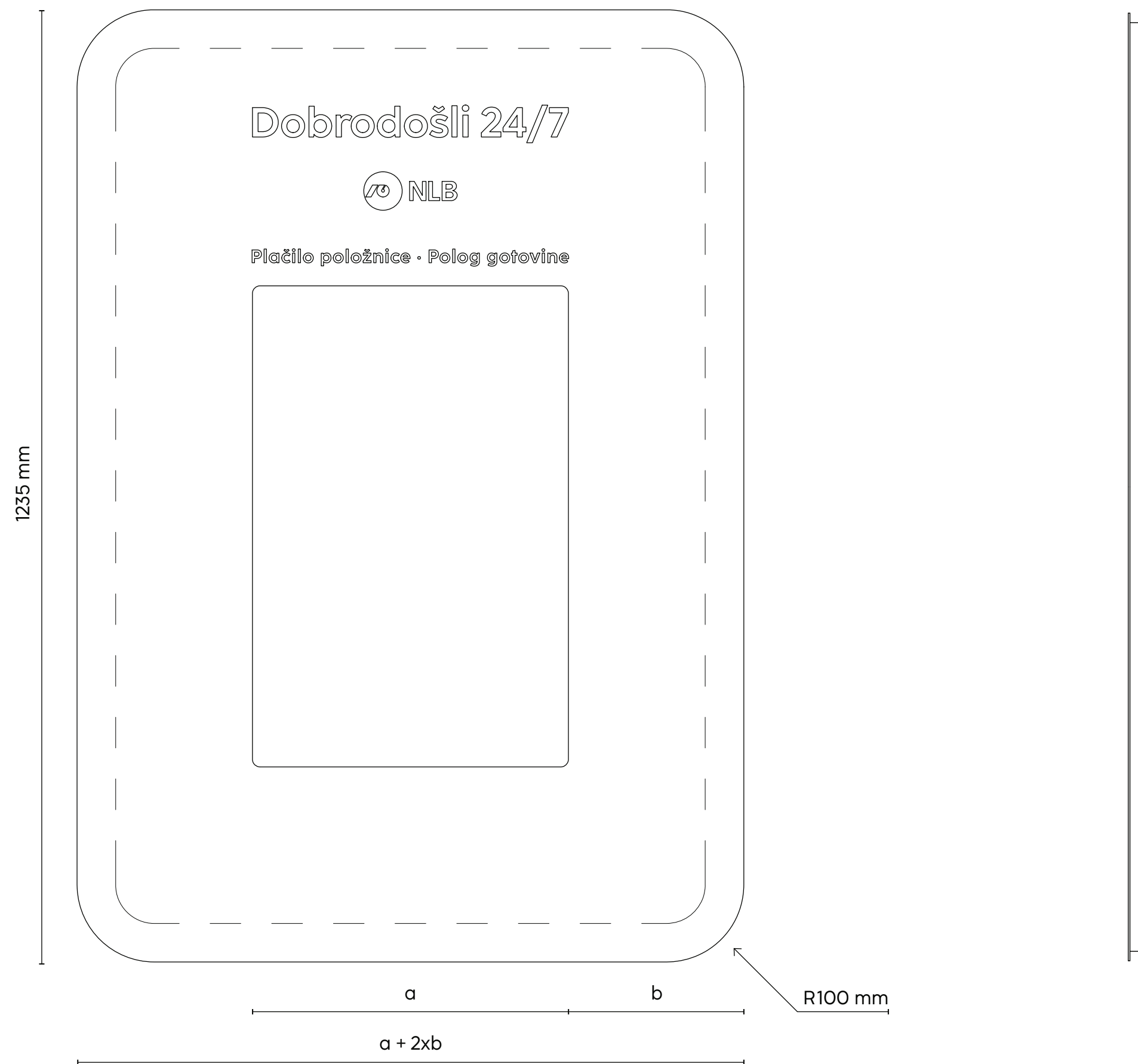

# Equipment of ATMs

## The Canopy

[www.nlb.si/brand/business-buildings/outdoor-signage/equipment-of-atms](http://www.nlb.si/brand/business-buildings/outdoor-signage/equipment-of-atms)

3D light elements	CODE
18. The Canopy for ATM	NLB_ATM_C

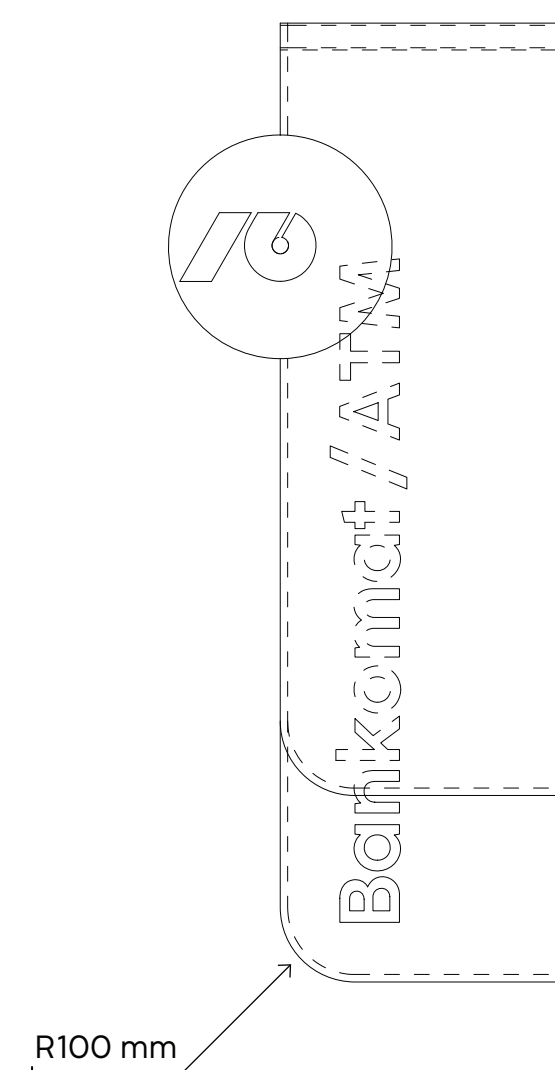
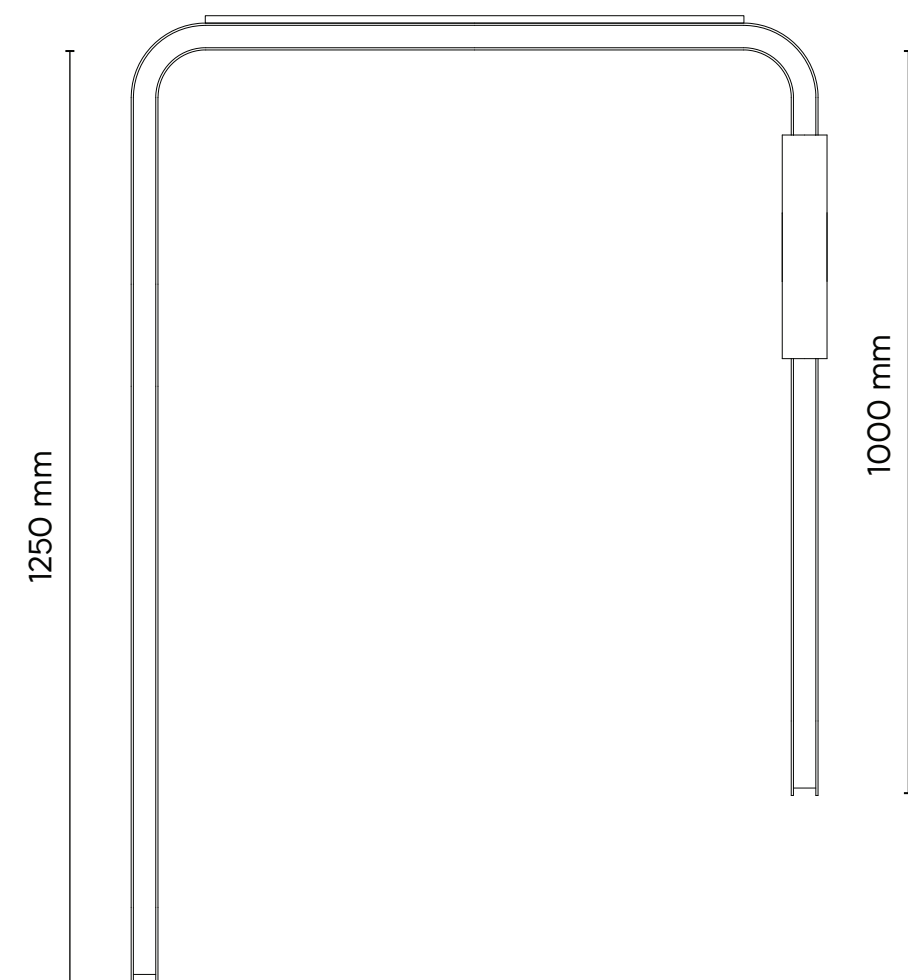

# Equipment of ATMs

## Freestanding ATM with light element

[www.nlb.si/brand/business-buildings/outdoor-signage/equipment-of-atms](http://www.nlb.si/brand/business-buildings/outdoor-signage/equipment-of-atms)

3D light elements	CODE
19. Freestanding ATM with light element	NLB_ATM_FS

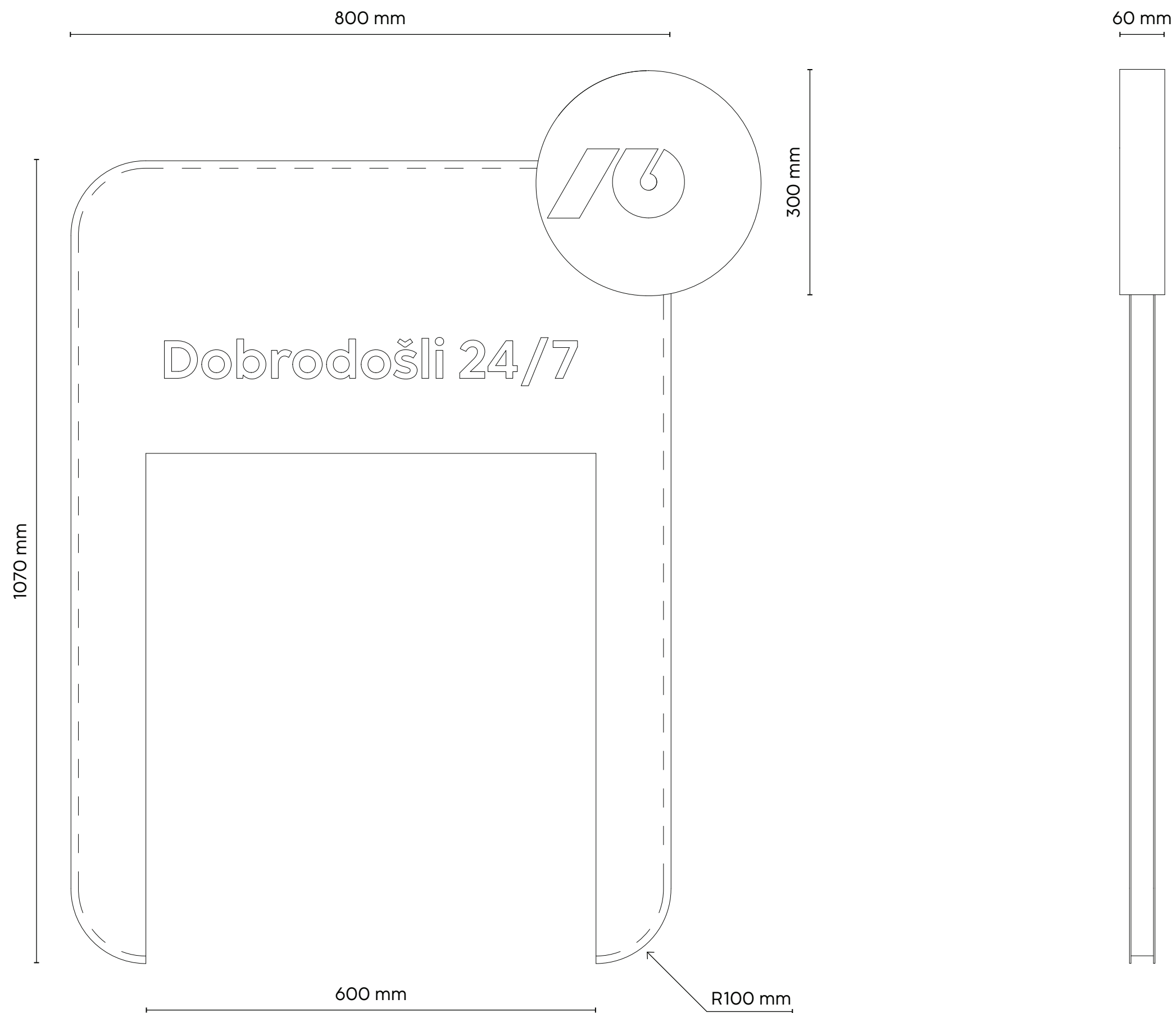

# Signage columns

- 1 Signage column 300 cm
- 2 Signage column 500 cm
- 3 Signage column with bench 300 cm





# Signage columns

## Signage column 300 cm

[www.nlb.si/brand/business-buildings/outdoor-signage/signage-columns](http://www.nlb.si/brand/business-buildings/outdoor-signage/signage-columns)

3D light elements	CODE
20. Signage column 300 cm	NLB_SC_300

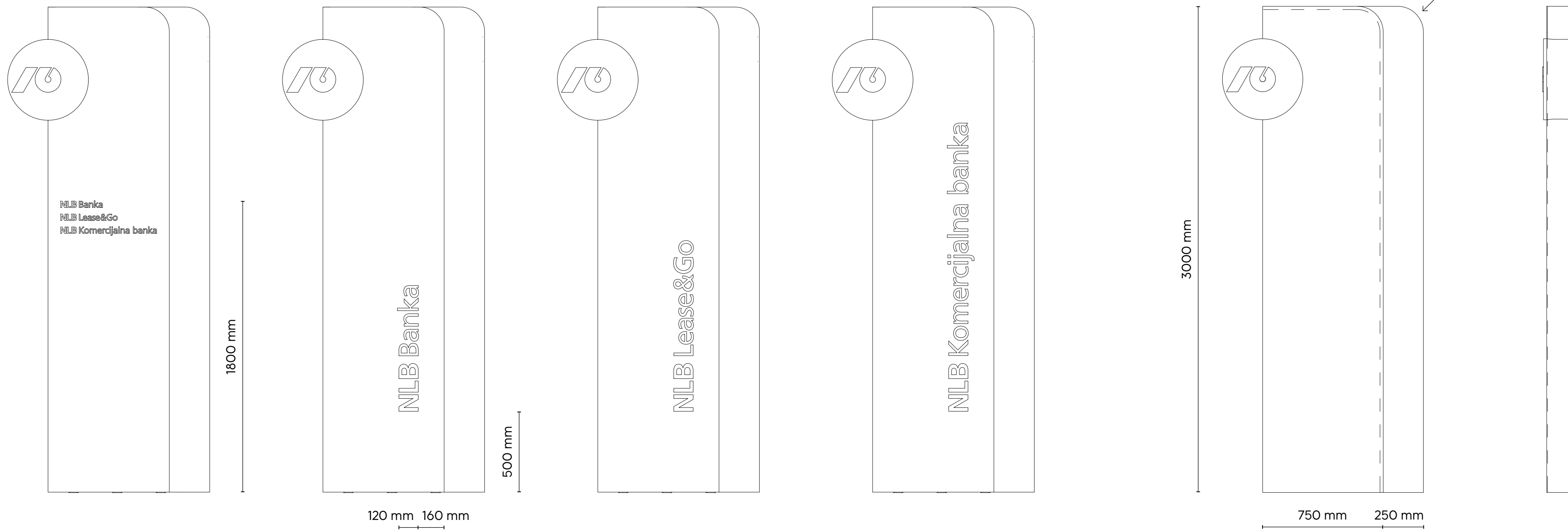

# Signage columns

## Signage column 500 cm

[www.nlb.si/brand/business-buildings/outdoor-signage/signage-columns](http://www.nlb.si/brand/business-buildings/outdoor-signage/signage-columns)

3D light elements	CODE
21. Signage column 500 cm	NLB_SC_500

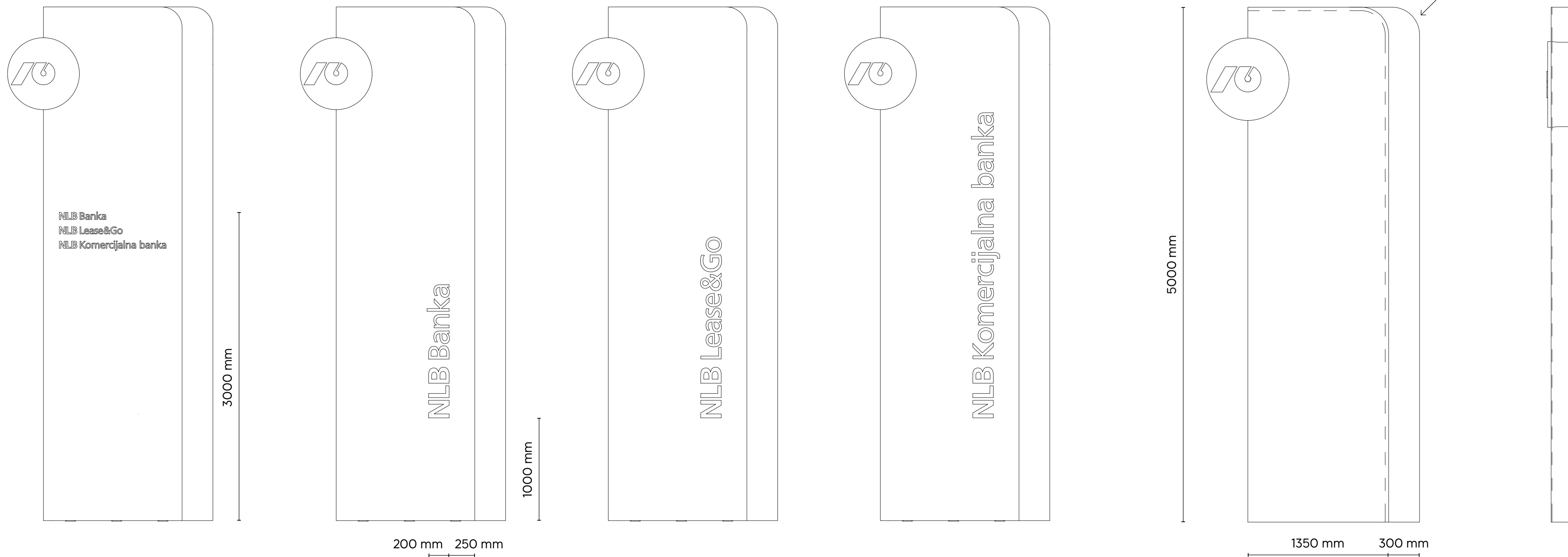

# Signage columns

## Signage column with bench 300 cm

[www.nlb.si/brand/business-buildings/outdoor-signage/signage-columns](http://www.nlb.si/brand/business-buildings/outdoor-signage/signage-columns)

3D light elements	CODE
22. Signage column with bench 300 cm	NLB_SC_300_B

